

FICHE TECHNIQUE

COUDE 90° • 2 x E45

Utilisé pour dévier le conduit de 90°.

Inclus :

- 2 Coudes à 45° (E45)
- 2 Bandes d'assemblage (AB)
- 2 Bandes de finition (FB)

K = 0.15

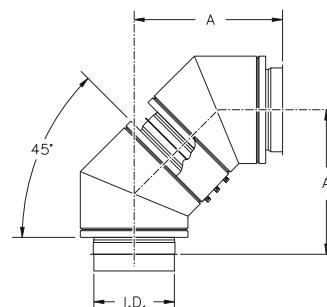

DOUBLE PAROI - 2"			
D.I.		A	
po	mm	po	mm
6	152	18.692	475
8	203	19.692	500
10	254	20.692	526
12	305	21.692	551
14	356	22.692	576
16	406	23.692	602
18	457	24.693	627
20	508	25.692	653
22	559	26.692	678
24	610	27.692	703
26	660	28.692	729
28	711	29.692	754
30	762	30.692	780
32	813	31.692	805
34	864	32.692	830
36	914	33.692	856
38	965	34.692	881
40	1016	35.692	907
42	1067	36.692	932
44	1118	37.692	957
46	1168	38.692	983
48	1219	36.692	1008

DOUBLE PAROI - 4"			
D.I.		A	
po	mm	po	mm
6	152	19.692	500
8	203	20.692	526
10	254	21.692	551
12	305	22.692	576
14	356	23.692	602
16	406	24.692	627
18	457	25.692	653
20	508	26.692	678
22	559	27.692	703
24	610	28.692	729
26	660	29.692	754
28	711	30.692	780
30	762	31.692	805
32	813	32.692	805
34	864	33.692	856
36	914	34.692	881
38	965	35.692	907
40	1016	36.692	932
42	1067	37.692	957
44	1118	38.692	938
46	1168	39.692	1008
48	1219	40.692	1034

DISPONIBLE POUR LES MODÈLES:

IPPL/IPPL2/IPPL2F/IPPL4F

HEPL/HEPL2

GDPL/GDPL2F/GDPL4F